

Blackstar⁺

PRODUCT CATALOGUE 2015



Introducing Blackstar

Welcome to the latest Blackstar Amplification product catalogue.

At Blackstar, we are all musicians and understand the importance of great tone, whether for practicing at home or on stage in a live environment. Based in Northampton, England, with over 60 years combined experience in guitar amplification design and production, we are totally committed to providing you with the ultimate tools for self-expression.

2015 heralds the launch of the ID:Core BEAM the Bluetooth and multi instrument amplifier. The BEAM's intuitive functionality and cool styling make it the perfect amplifier for home use.

We hope our unique and patented innovations will take you a step closer to realising the 'sound in your head'.

The Blackstar Team



Blackstar would like to thank: Adrenaline Alley (Corby), Death House Studio (Northampton), The Cavern Club (Liverpool), Birmingham Institute, The Roadmender (Northampton), The Lodge Studio (Northampton), The Zombie Hut (Corby), and KOKO (London) for the use of their historic venues seen within the pages of this brochure.

Photos: Paul Michael Hughes, Brochure photography: www.paulmichaelhughes.com



Company History

In 2004 four friends, all band mates, were looking for a new challenge. Having worked together for years at the highest levels of the amp designing industry, their dream was to create new and innovative guitar amplifiers and pedals that would be the ultimate tools for self-expression.

Following two and a half years intensive technical research in a garden shed in Northampton England, the first Blackstar products were ready and in March 2007, Blackstar was officially launched at the Frankfurt Musikmesse. Since then we have moved from the garden shed to our own premises, which have a purpose built lab and studio and we've been lucky enough to add some amazingly talented people to our team.

Four years on, we have been on a remarkable journey and been privileged to meet some incredible people from all over the world and call them our friends. From artists like Gus G. (Ozzy Osbourne/Firewind), Richie Sambora (Bon Jovi), Neal Schon (Journey), Silenoz (Dimmu Borgir) and Steve Cradock (Paul Weller band), to the many players that support us and come and meet us at shows.

Since those early days we have continued to grow as a company, but one thing remains true. We're all musicians and are truly passionate about what we do – making great guitar amps for players around the world.



The garden shed where it all began



Frankfurt Musik Messe stand 2007



The Blackstar Team



“Welcome to the Church of Distortion.”

Gus G. – Ozzy Osbourne / Firewind

Where innovation meets tone

At Blackstar we believe that guitar amplifier design is not voodoo or a black art – it is the application of engineering discipline in a musical setting. The real magic happens when we are able to provide you, the musician, with products that inspire you in your art. This philosophy drives us to truly understand the science of great guitar tone and deliver products that really deliver ‘the sound in your head’.

We create every product at Blackstar ‘from the ground up’ as opposed to simply tweaking the old classic designs. Each Blackstar circuit contains numerous innovations, in addition to unique breakthrough technologies such as ISF and DPR. It is often these small yet important enhancements that give Blackstar products their characteristic sound clarity and flexibility.

These sonic innovations are only available on Blackstar products.

Put simply – ‘Blackstar amps sound different because they are different!’

Tri Patent Design

At our HQ in Northampton, England, we have an ongoing program of research and development which seeks to constantly challenge the state-of-the-art in guitar amplifier technology. We believe it is our dedication to research and innovation that sets us, and our products, apart.

Patented innovations like TVP, ISF and DPR are the foundations of the Blackstar product catalogue and our commitment to helping guitarists achieve the sound in their heads.



Infinite Shape Feature (ISF)

The conventional three way guitar EQ network, or tone stack (a.k.a. Bass, Middle and Treble), is a key to the characteristic ‘voice’ of traditional guitar amplifiers. Classic amplifier designs have their own versions of this network which leads to their own tonal voicings.

The ISF control allows you to infinitely adjust the response of the tone control network between any of the traditional voicings in a way that has never before been possible. In this way you can design your own sound and truly find ‘the sound in your head’.

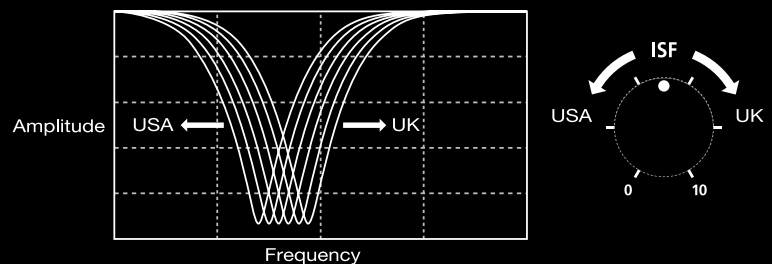

Benefits of the ISF control:

1. ISF is a passive circuit giving a musical response that is not found in active parametric or ‘contour’ controls.
2. The whole tone stack response (i.e. Bass, Middle and Treble) is moved.
3. The tone controls remain fully interactive, just like in a regular tone stack.
4. The ISF control is continuously variable between all the traditional responses allowing you to effectively design your own sound.
5. ISF and ‘the sound in your head’ are only available on Blackstar products.

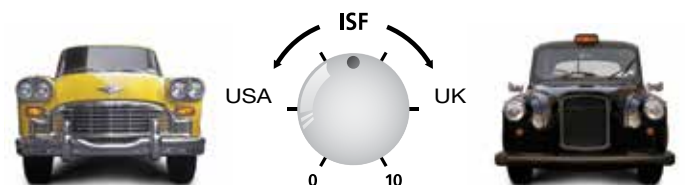

USA to UK in seconds

Dynamic Power Reduction (DPR)

Everyone knows that valve amplifiers sound best when they are turned up loud. This is because at higher volume levels the output valves introduce musical distortion and compression which are a vital part of the valve amplifier experience.

Blackstar's patented DPR feature controls the output power level by dynamically adjusting the output stage voltages, allowing power valve distortion and compression at any volume level.

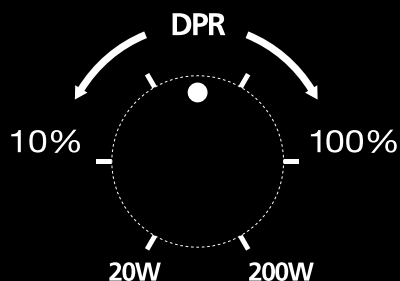

Benefits of the DPR control:

1. DPR allows continuously variable power reduction, down to 10%, so you can use your valve amp in any playing situation.
2. DPR is a 'dynamic' circuit, delivering the exact compression (a.k.a. sag) of a small overdriven valve amp, at any volume level.
3. Unlike power attenuators, DPR places nothing between the output of the amplifier and the loudspeaker and hence as the power is reduced the feel, tone and reliability of the amplifier is maintained.
4. DPR's dynamic power reduction is only available on Blackstar products.

CONCENTRATED
TO
CONCERT-RATED **WW**
Dynamic Power Reduction

True Valve Power (TVP)

It is widely accepted that a valve guitar amplifier with a 100 Watt power rating will sound considerably louder than an equivalent non-valve amplifier. Blackstar's patent-applied-for TVP technology allows for the first time the combination of the tonality, distortion characteristics and crucially, the perceived sound pressure levels, of an equivalent valve power amplifier.

TVP delivers six distinctly different power valve responses – EL84, 6V6, EL34, KT66, 6L6, KT88. When engaged it delivers the response, dynamics, sag and break-up characteristics of a valve amp.

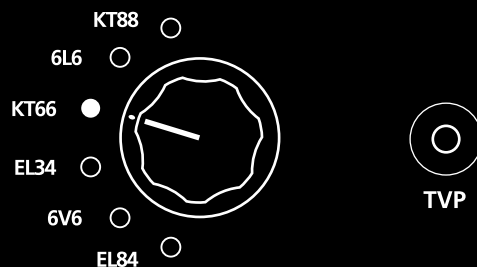

Benefits of the TVP control:

1. TVP generates the same output volume as an equivalent rated valve amp – True Valve Power means LOUD as valve™.
2. TVP accurately delivers the responsive 'feel' of a valve amplifier.
3. TVP offers a choice of six different power valve responses, from tight and dynamic to compressed and spongy.
4. Mix and match Voice, ISF and TVP settings to achieve 'the sound in your head'.



Blackstar Artists



Richie Sambora

Bon Jovi

"From studios to stadiums, these are the amps I use."



Neal Schon

Journey

"The Blackstar Series One 100 is one of the best sounding amps that I've played through. It produces a powerful punchy-smooth-warm and precise sound. Great dependable amps."



Uli Jon Roth

Scorpions, Sky Avalon, Electric Sun

"I love the Blackstar Artisan 100! Easily my favourite amp on the market today! It has a fantastic overall response, is extremely well built and totally reliable."



Silenoz

Dimmu Borgir

"The Series One 200 is the very definition of guitar sound and will break new ground – mark my words!"



Paul Allender

Cradle of Filth

"The Series One 200 is like having angels crying on my tongue, but tastes far sweeter!"



Mike Spreitzer

DevilDriver

"The Blackstar Series One 1046L6 is a BEAST of an amp! Versatile and reliable... through and throughout."



El Hefe

NOFX

"The Blackstar HT Stage 100 is a must have amp for the recording studio. It's like four heads in one."



Alex Robertshaw

Everything Everything

"The Artisan 30 is the best amp I've used."



Richard Hawley

"The Artisan 15 has the English old school sound and tone and you don't need a f***in' map to tell you how all the levers work."



Steve Cradock

Paul Weller, Ocean Colour Scene

"The Artisan 30 has great tone! I've got three of the little f***ers in line!"



James Dean Bradfield

Manic Street Preachers

"I love this amp!" (Artisan 30 user)



Gaz Coombes

Supergrass/Hot Rats

"The Artisan 30 has all the vintage tones in one box."



Joshua Third

The Horrors

"Now I have the Artisan 15H, people that are hearing my tone are like, Sploosh."



Sammy Hagar

Chickenfoot, Warburton

"The Blackstar sound is inspiring" Series One 100 user



Fraser Taylor

Young Guns

"The Series One 100 is my ideal amp. Leads cut through perfectly, it's got plenty of meat for the riffs and all finished off with an excellent warm clean tone. Love it!"



Nicke Borg

Backyard Babies

"I need to be able to go from 0-100 in seconds. That's why I drive a Chrysler 300C and play a Blackstar Series One 100."



Lu Edmonds

PIL

"I can get the most singing of lead tones, the crunchiest of rhythms and angelic cleans with both my Series One 200 and my HT Studio 20. Just searing!"



Seth

Behemoth

"A Series One 200 is the answer for all those guitar players who constantly search for new sounds, crystallising the musical path they chose at the very beginning..."



Jeff Kendrick
DevilDriver

"The Blackstar Series One 1046L6 has the edge that makes DevilDriver sound the way we need to sound live. The tone is absolutely crushing!"



Matt Pike
High on Fire

"Everyone loves some thunder." (Series One 100 user)



Ihsahn
Emperor

"All the clarity and punch I expect from a valve head. Blackstar's designers obviously have the modern guitar player in mind." (Series One 200 user)



Leslie West
Mountain

"Open the throttle up and go into overdrive." (Series One 100 user)



Jeff Stinco
Simple Plan

"The Artisan 30 has so much personality and vibe, it's really made my live playing experience so much better. It sounds beyond amazing."



Bob Mould
Solo Artist

"I picked up my cable, plugged into the Artisan 100 and thought, this is the best amp I've ever played."



Huey Morgan
Fun Lovin' Criminals

"This is how I roll!" (HT Stage 100 user)



James Williamson
Iggy & the Stooges

"From the first time I fired up the Blackstar Artisan 30H... Wow, wow, wow... it sounded fantastic!"



Pat Travers
The Pat Travers Band

"The Artisan 100 is the best amp I have ever plugged a guitar into."



Tommy Henriksen
Alice Cooper

"I hit an 'A' chord and the S1-104EL34 screamed 'F-CK YOU!' I knew I was in love!!"



Billy Lunn
The Subways

"This is how we make buildings fall down." (Artisan 30 user)



Boz Boorer
Morrissey

"It's nice to see the reliability and class of British engineering and design is alive and living under the banner of Blackstar Amplification." (Artisan 30 user)



Stitch D
The Defiled

"Blackstar simply rules! Tonally I can get anything from classic rock to full-on face melting metal!" (Series One 1046L6 user)



Micko Larkin
Hole

"If you're going to play, go all the way. There are no other amps like Blackstar. This is the only good amp there is, and I'm playing it." (HT SOLOIST 60 user)



Joe Don Rooney
Rascal Flatts

"Clarity! Clarity can be a rarity when it comes to finding a great amp, but the first Blackstar I plugged into I heard clarity like no other." (Series One 200 user)



Mark Collins
The Charlatans

"Sounds great, looks great, versatile amp. Love it." (Artisan 30 user)



Reb Beach
Winger, Whitesnake

"The HT-5 is perfect for my smaller gigs, and people always flip when they hear such a big tone from a small amp."



Mike Duce
Lower Than Atlantis

"I've never, ever been happy with a guitar tone... but then I found Blackstar." (Series One 1046L6 user)



SERIES ONE

The New #1

SERIES ONE delivers incredible high gain performance with a level of tonal refinement found previously only in the very best boutique and vintage amps.

A close-up, low-angle shot of the Blackstar 100 Series One guitar amplifier. The amp is black with a silver mesh grille. The 'Blackstar' logo is prominently displayed in white, raised lettering on the grille. Below the grille, the control panel features several knobs: three frequency controls (BASS, MIDDLE, TREBLE) with '10' markings, a '15F' knob, a 'RESONANCE' knob, a 'PRESENCE' knob, a 'VOLUME' knob, and a 'POWER' knob with '100' and 'SERIES ONE' markings. To the right, there is a 'STANDBY' switch with a glowing orange indicator light and a 'POWER' switch. The background is a blurred stage with blue and purple lighting.

Blackstar®

100
SERIES ONE

Black patent design BLACKSTAR

SERIES ONE

SERIES ONE 45

The S1-45 delivers both Class A style clean tones and classic push-pull crunch depending on the mode selected. ISF allows you to exactly tune your sound and DPR reduces the power down to 4.5W. Celestion custom designed lightweight Neo 12" speakers, MIDI switching and a series effects loop make this the ultimate pro's combo.

- 45 Watt combo with DPR
- 3 x ECC83, 1 x ECC82, 2 x EL34 valves
- 2 channels and 4 modes (footswitchable)
- Clean channel with Warm (Plexi) and Bright (Class A) modes
- Overdrive channel with Crunch and Super Crunch modes
- ISF equipped tone controls
- Presence and Resonance controls
- Master Volume
- Series effects loop
- MIDI switching
- Speaker emulated output
- 2 x Celestion Vintage 30's
- Finger-jointed birch plywood cabinet
- Welded steel chassis

SERIES ONE 50

The S1-50 is a 50W two channel, four mode EL34 valve head and boasts all the same tones, features and versatility of the S1-100.

- 50 Watt valve head with DPR
- 3 x ECC83, 1 x ECC82, 2 x EL34 valves
- 2 channels and 4 modes (footswitchable)
- Clean channel with Warm (Plexi) and Bright (Class A) modes
- Overdrive channel with Crunch and Super Crunch modes
- ISF equipped tone controls
- Presence and Resonance controls
- Master Volume
- Series effects loop
- MIDI switching
- Speaker emulated output
- Finger-jointed birch plywood cabinet
- Welded steel chassis





SERIES ONE 100

Built on the rock-solid foundation of the classic 100W EL34 power stage, the S1-100 sets new standards for clean and crunch tones. This amp has two channels and four footswitchable modes, complete with ISF, and includes the amazing Super Crunch for the biggest, crunchiest tones yet heard.

- 100 Watt head with DPR
- 3 x ECC83, 1 x ECC82, 4 x EL34 valves
- 2 channels and 4 modes (footswitchable)
- Clean channel with Warm (Plexi) and Bright (Class A) modes
- Overdrive channel with Crunch and Super Crunch modes
- ISF equipped tone controls
- Presence and Resonance controls
- Master Volume
- Series effects loop
- MIDI switching
- Speaker emulated output
- Finger-jointed birch plywood cabinet
- Welded steel chassis



Series One 45

Series One 45

Series One 45

Series One 100

Series One 100

www.blackstaramps.com/seriesone

SERIES ONE

SERIES ONE 1046L6

The S1-1046L6's power stage is loaded with a quartet of 6L6 valves and is voiced to appeal to the modern high gain player looking for the ultimate aggressive US metal sound. Four channels of bone shattering tone are delivered in a cool new 'stealth' look.

- 100 Watt valve head with DPR
- 4 x ECC83, 1 x ECC82, 4 x 6L6 power valves
- 4 channels (footswitchable)
- Clean channel with Warm (Plexi) and Bright (Class A) modes
- Crunch channel with Crunch and Super Crunch modes
- Two overdrive channels with high and low output damping
- Two ISF equipped tone controls
- Presence and Resonance controls
- Master Volume
- Series effects loop
- MIDI switching
- Speaker emulated output
- Finger-jointed birch plywood cabinet
- Welded steel chassis

SERIES ONE 104EL34

Four EL34 power valves form the backbone of the S1-104EL34. This high gain power house provides unbelievable dynamics and head-room delivering the ultimate in British rock tones.

- 100 Watt valve head with DPR
- 3 x ECC83, 1 x ECC82, 4 x EL34 power valves
- 4 channels (footswitchable)
- Clean channel with Warm (Plexi) and Bright (Class A) modes
- Crunch channel with Crunch and Super Crunch modes
- Two overdrive channels with high and low output damping
- Two ISF equipped tone controls
- Presence and Resonance controls
- Master Volume
- Series effects loop
- MIDI switching
- Speaker emulated output
- Finger-jointed birch plywood cabinet
- Welded steel chassis

SERIES ONE 412PRO A/B

These 'standard' sized cabinets are designed to produce a more balanced mid range response. Loaded with a new Celestion 8 Ohm Vintage 30, exclusively developed for Blackstar, they have tone and projection unlike any other in their class.

- 240W / 8 Ohm angled or straight standard size 4x12" extension cabinets
- Switchable mono / stereo
- Finger-jointed birch plywood construction
- Special baffle construction for more balanced mid range response
- Heavy gauge wire
- Custom-voiced 8 Ohm Celestion Vintage 30 speakers



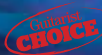

Series One 200

Series One 200

SERIES ONE 200

The S1-200 has all the tonal refinement of the S1-45 and S1-100, but with an additional two ultra high gain overdrive channels. Combine this with the muscle of a 200W KT88 power amp and you have a true metal monster.

- 200 Watt head with DPR
- 4 x ECC83, 1 x ECC82, 4 x KT88 valves
- 4 footswitchable channels
- Clean channel with Warm (Plexi) and Bright (Class A) modes
- Crunch channel with Crunch and Super Crunch modes
- Two Overdrive channels with high and low output damping
- Two ISF equipped tone controls
- Presence and Resonance controls
- Master Volume
- Series effects loop
- MIDI switching
- Speaker emulated output
- Finger-jointed birch plywood cabinet
- Welded steel chassis

SERIES ONE 212

The S1-212 is a 2x12 cabinet perfect for use as an extension cabinet for the S1-45 combo, or as a compact cab for use with a Series One head. Loaded with Celestion Neo 12" speakers it has excellent tone and focus.

- 120W / 16 Ohm 2x12" extension cabinet
- Switchable mono /stereo
- Finger-jointed birch plywood construction
- Heavy gauge wire
- Celestion Neo 12" speakers

SERIES ONE 412 A/B

These 'oversized' Blackstar 4x12 cabinets are handwired and built to the highest standards using the finest materials. Every care has been taken with the design of these cabinets to ensure that they produce the best possible sounds and will really last a lifetime.

- 240W / 16 Ohm angled or straight standard size 4x12" extension cabinets
- Switchable mono / stereo
- Finger-jointed birch plywood construction
- Special baffle construction for more balanced mid range response
- Heavy gauge wire
- Celestion Vintage 30 12" speakers

www.blackstaramps.com/seriesone



BI

I II
I II

VOLUME I VOLUME II

PLASTIC

W & THE

GIN
BAYS

BIG
BAY

THE
TAYLOR
BOWLING

WYMAN

THE HIDEAWAY

ROAD

HANDWIRED
ARTISAN SERIES
AMPLIFIERS

HAND-CRAFTED TONE

The award-winning Artisan Series of handwired amplifiers represents the absolute highest standard of craftsmanship and all-valve boutique tone.

Blackstar®





ARTISAN 15

The ARTISAN 15 – beautiful looks and beautiful tone. Two channels, one based on an EF86 Pentode and the other an ECC83 Triode, refine legendary vintage and boutique reference tones.

- Class A 15W ■ Switch for 5W triode mode / 15W pentode mode ■ 2 x EL84 output valves
- EF86 channel ■ ECC83 channel ■ Hi and Lo inputs perfect for channel blending ■ Impedance selector ■ Vintage G12M Celestion speaker

ARTISAN 15H

A portable head version of the acclaimed ARTISAN 15.

- Class A 15W ■ Switch for 5W triode mode / 15W pentode mode ■ 2 x EL84 output valves
- EF86 channel ■ ECC83 channel ■ Hi and Lo inputs perfect for channel blending
- Impedance selector

ARTISAN 212

This 2x12 cabinet is handwired and built to the highest standards using the finest materials. Every care has been taken with the design to ensure that it produces the best possible sounds and really will last a lifetime.

- 120W / 16 Ohm extension cabinet ■ Mono / stereo ■ Finger-jointed birch plywood construction
- Heavy gauge wire ■ Celestion Vintage 30 speakers





HAND-CRAFTED TONE

Point-to-point tag board construction, welded steel chassis and finger-jointed birch ply cabinets are complemented by beautiful vintage red covering.



Artisan 15 Chassis



Artisan 15

www.blackstaramps.com/artisan



ARTISAN 30

There is something magical in the sonic qualities of the 30W EL84 power stage driving a pair of classic British speakers. The ARTISAN 30 takes this tone and distills it to a new level of tonal purity.

- Class A 30W ■ Switch for 10W triode mode / 30W pentode mode ■ 4 x EL84 output valves
- EF86 channel with 5-way Bass Shape switch
- ECC83 channel with 2-way Voice switch and Master Volume ■ Hi and Lo inputs perfect for channel blending ■ Impedance selector
- 2 x Celestion Vintage 30 speakers

ARTISAN 30H

The award-winning ARTISAN 30 in a classic head format.

- Class A 30W ■ Switch for 10W triode mode / 30W pentode mode ■ 4 x EL84 output valves
- EF86 channel with 5-way Bass Shape switch
- ECC83 channel with 2-way Voice switch and Master Volume ■ Hi and Lo inputs perfect for channel blending ■ Impedance selector

ARTISAN 412 A/B

The oversized vintage Blackstar 4x12 cabinets are handwired and built to the highest standards using the finest materials. Every care has been taken with the design of these cabinets to ensure that they produce the best possible sounds and will really last a lifetime.

- 240W / 16 Ohm extension cabinet ■ Switchable mono / stereo ■ Finger-jointed birch plywood construction ■ Heavy gauge wire ■ Celestion Vintage 30 speakers





HAND-CRAFTED TONE

With the emphasis on simplicity and sonic purity, every feature has been refined to provide the artist with the widest range of reference vintage tones.

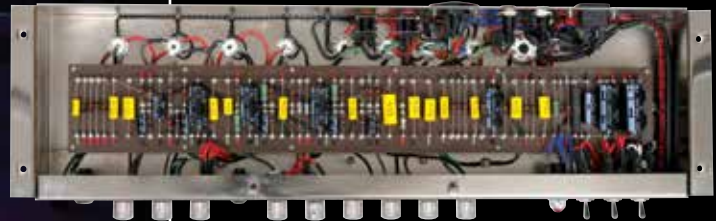

Artisan 30 Chassis



Artisan 30



Best Amplifier

Artisan 30

www.blackstaramps.com/artisan



ARTISAN 100

The ARTISAN 100 takes the boutique 100W format to a whole new level of flexibility. The Voice control is a time line of the evolution of the genre from the early American designs through to British designs of the '60s and '70s.

- 100W head ■ 4 x EL34 output valves
- 4-way Voice switch is a time line of 100W designs
- Hi and Lo inputs perfect for channel blending
- Impedance selector





HAND-CRAFTED TONE

Each Artisan amplifier is designed to offer the widest range of classic vintage and boutique tones to the highest possible sonic standard. This is achieved by the design of electronic circuits that work in harmony with the finest components and materials available.

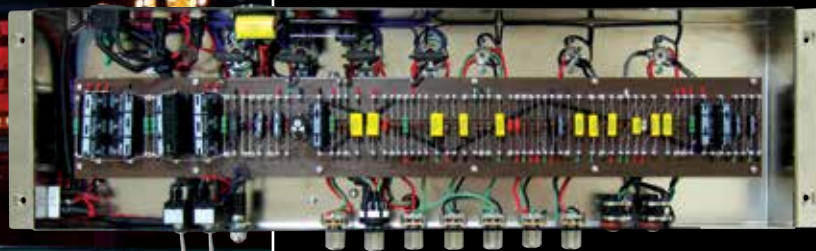

Artisan 100 Chassis

Artisan 100

www.blackstaramps.com/artisan



INPUT

CLEAN

OVERDRIVE



0

10

VOICE



0

10

TONE



OD SELECT



0

10

VOICE

0

VOLUME

GAIN

Bl

HT VENUE SERIES

Inspiration from studio to stage

With authentic 'boutique' cleans and super high gain overdrives the HT Venue Series of valve amps is packed with innovations and tones to inspire your performance.



HT VENUE SERIES

HT STUDIO 20

This amp offers huge versatility for home, rehearsal or studio use. The carefully voiced preamp, coupled with a cathode-biased EL34 power amp, provides you with the ability to create wonderfully lush valve tones. Plus you get reverb, an effects loop and an emulated output. From pure boutique cleans, to mild overdrive that cleans up by backing off the guitar volume control, right up to saturated distortion, this amp does it all.

- 20 Watt valve combo ■ 2 x ECC83, 2 x EL34 valves ■ Two footswitchable channels
- 12" Celestion speaker ■ Enhanced tone controls
- Patented Infinite Shape Feature (ISF)
- Master Volume ■ Digital reverb
- Speaker emulated output ■ Effects loop
- 1-way footswitch included

HT STUDIO 20H HEAD

This head version of the HT Studio 20 combo offers the same versatility in a compact and portable format. Perfectly matched to the HTV-112 cabinet, it can easily drive a 4x12.

- 20 Watt valve head ■ 2 x ECC83, 2 x EL34 valves
- Two footswitchable channels ■ Enhanced tone controls
- Patented Infinite Shape Feature (ISF)
- Master Volume ■ Digital reverb ■ Speaker emulated output ■ Effects loop
- 1-way footswitch included





PLEASE
MIND YOUR
HEAD

Blackstar®

Blackstar®

HT Studio 20

HT Club 40

HT CLUB 40

Equipped with two channels and four modes, the HT Club 40 is the ideal gigging valve amp for club sized venues. The 40W EL34 driven power amp has amazing punch and dynamics that will easily cut through in a full band situation. With a Celestion speaker, reverb, emulated output and effects loop this amplifier will set a new standard for flexible, gigging valve combos.

- 40 Watt valve combo
- 2 x ECC83, 2 x EL34 valves
- Two footswitchable channels
- 12" Celestion speaker
- Enhanced tone controls
- Patented Infinite Shape Feature (ISF)
- Clean Voice switch
- Overdrive Voice switch
- Master Volume
- Digital reverb with dark/bright switch
- Speaker emulated output
- Effects loop
- 2-way footswitch included

HT CLUB 50 (Product not shown)

Equipped with two channels and four modes the HT Club 50 is the ideal valve amp for club sized venues. The 50W EL34 driven power amplifier has amazing punch and dynamics that will easily cut through in a full band situation. With studio quality reverb, speaker emulated output and effects loop this amplifier sets a new standard for flexible, gigging valve heads.

- 50 Watt valve head
- 2 x ECC83, 2 x EL34 valves
- Two footswitchable channels
- Enhanced tone controls
- Patented Infinite Shape Feature (ISF)
- Clean Voice switch
- Overdrive Voice switch
- Master Volume
- Digital reverb with dark/bright switch
- Speaker emulated output
- Effects loop
- 2-way footswitch included

HTV-112

- 80W extension cabinet
- Mono
- Finger-jointed construction
- Heavy gauge wire
- 1 x Celestion 12" loudspeaker

HTV-212

- 160W extension cabinet
- Mono / stereo
- Finger-jointed construction
- Heavy gauge wire
- 2 x Celestion 12" loudspeakers

www.blackstaramps.com/htvenue

HT VENUE SERIES

HT SOLOIST 60

The ultimate compact gigging amp for players who want the power to handle larger venues but in a 1x12 combo format. Two channels with four modes are augmented by a Boost level control which can add up to 10dB of specially voiced boost. Using the OD Body switch you can also add extra mid range gain to the overdrive channel for fat, singing leads. Built to last, this combo comes fully equipped with a Celestion speaker, reverb, emulated output, 4-way footswitch and effects loop.

- 60 Watt valve combo ■ 2 x ECC83, 2 x EL34 valves ■ Two footswitchable channels
- 12" Celestion speaker ■ Enhanced tone controls
- Patented Infinite Shape Feature (ISF)
- Clean Voice switch ■ Overdrive Voice switch
- Footswitchable Boost with OD Body switch
- Presence ■ Master Volume ■ Digital reverb with dark/bright switch ■ Speaker emulated output with 1x12 / 4x12 voicing ■ Effects loop with effects level switch ■ 4-way footswitch included

HT STAGE 60

The HT Stage 60's selected duet of EL34s delivers 60W of glorious valve power through two Celestion speakers, making for a combo that will deliver every night, even in the most testing live environment. This no-compromise workhorse is fully equipped with Celestion speakers, reverb, emulated output, 4-way footswitch and effects loop.

- 60 Watt valve combo ■ 2 x ECC83, 1 x ECC82, 2 x EL34 valves ■ Three footswitchable channels ■ 2x12" Celestion speakers ■ Enhanced tone controls ■ Patented Infinite Shape Feature (ISF) ■ Clean Voice switch ■ Overdrive 1 Voice switch ■ Overdrive 2 Voice switch
- Presence ■ Resonance ■ Master Volume
- Digital reverb with dark/bright switch
- Speaker emulated output with 1x12 / 4x12 voicing ■ Effects loop with effects level switch
- 4-way footswitch included





HT STAGE 100

The HT Stage 100 uses a quartet of selected EL84 power valves to deliver 100W of British dynamics with three channels delivering 6 modes for amazing tonal versatility. The 'boutique' style clean channel is extremely versatile with two modes – 'British Class-A' and 'dynamic US'. Each of the two ISF equipped overdrive channels allows a further two voicing modes. OD1 has 'classic' and 'modern crunch' modes and OD2 has 'standard' and 'super high gain lead' modes. Adding an optional 1-way footswitch allows you to also switch the OD2 voice switch, effectively giving you a solo boost. This powerhouse is fully equipped with reverb, emulated output, 4-way footswitch and effects loop.

- 100 Watt valve head
- 2 x ECC83, 1 x ECC82, 4 x EL34
- Three footswitchable channels
- Enhanced tone controls
- Patented Infinite Shape Feature (ISF)
- Clean Voice switch
- Overdrive 1 Voice switch
- Overdrive 2 Voice switch
- Presence
- Resonance
- Master Volume
- Digital reverb with dark/bright switch
- Speaker emulated output with 1x12 / 4x12 voicing
- Effects loop with effects level switch
- 4-way footswitch included

HTV-412A

- 320W angled extension cabinet
- Mono / stereo
- Finger-jointed construction
- Heavy gauge wire
- 4 x Celestion 12" loudspeakers

HTV-412B

- 320W straight extension cabinet
- Mono / stereo
- Finger-jointed construction
- Heavy gauge wire
- 4 x Celestion 12" loudspeakers

CRUISER
CHOICE

HT Soloist 60

CRUISER
CHOICE

HT Stage 60

JUST
GUITAR
BEST BUY

HT Stage 60

CRUISER
CHOICE

HT Stage 100



POWER STANDBY

MASTER



ON

ON

VOLUME

PRESENCE

RESONANCE

HT METAL 100

IRON

UIGUAW

A close-up, low-angle shot of a Blackstar HT Metal Series guitar amplifier. The amplifier is black with a silver honeycomb grille. The 'Blackstar' logo is prominently displayed in white on a black background across the grille. Below the grille, the control panel features several knobs and a switch. From left to right, there are five knobs labeled 'LEVEL', 'OD1', 'TREBLE', 'MIDDLE', and 'BASS'. Above the 'OD1' knob is the text 'OD 1 / OD2 EQUALISATION'. To the right of these knobs is a 'VOLUME' knob with a red LED indicator light. Further right is a 'CLEAN' switch and another 'VOLUME' knob. The background is a dimly lit room with posters on the wall, including one for 'UFO' and another with 'JOY DIVISION' partially visible. A warm, glowing light source is visible in the upper right background.

Blackstar

VERB

OD 1 / OD2 EQUALISATION

VOLUME

CLEAN

LEVEL OD1 TREBLE MIDDLE BASS

VOLUME

TREBLE MIDDLE BASS

TO HELL

HT METAL SERIES

HT METAL 1

An innovative 1 Watt, two channel valve combo that packs all the features of the award-winning HT-1 and kicks up the gain to produce a true metal beast.

- Innovative 1 Watt combo ■ 1 x ECC83 and 1 x ECC82 ■ Unique push-pull power amp design
- Two channels ■ 8" speaker ■ Extreme gain and tone ■ Patented Infinite Shape Feature (ISF)
- Speaker emulated output ■ Stereo MP3 / Line input ■ External speaker output ■ Reverb ■ Custom 'metal' styling ■ Metal logo

HT METAL 1H

A head version of the HT METAL 1 combo. Toneful, portable and powerful enough to drive a 4x12.

- Innovative 1 Watt head ■ 1 x ECC83 and 1 x ECC82 ■ Unique push-pull power amp design
- Two channels ■ Extreme gain and tone
- Patented Infinite Shape Feature (ISF) ■ Speaker emulated output ■ Stereo MP3 / Line input
- External speaker output ■ Reverb ■ Custom 'metal' styling ■ Metal logo

HT METAL 5

Extreme metal voicing and a unique 5W push-pull design, ensure the HT METAL 5 combo delivers huge tone at any volume.

- Innovative 5 Watt combo ■ 1 x ECC83 and 1 x 12BH7 ■ Unique push-pull power amp design
- Two footswitchable channels (footswitch included)
- 12" Blackstar Blackbird speaker ■ Extreme gain and tone ■ Patented Infinite Shape Feature (ISF) ■ Speaker emulated output with 1x12 / 4x12 voicing
- Effects loop with effects level switch ■ Reverb ■ Custom 'metal' styling ■ Metal logo

HT METAL 5H

A head version of the HT METAL 5 combo. With all the same great features and tone it's compact and portable, and more than capable of driving a 4x12!

- Innovative 5 Watt head ■ 1 x ECC83 and 1 x 12BH7 ■ Unique push-pull power amp design
- Two footswitchable channels (footswitch included)
- Extreme gain and tone ■ Patented Infinite Shape Feature (ISF) ■ Speaker emulated output with 1x12 / 4x12 voicing
- Effects loop with effects level switch
- Reverb ■ Custom 'metal' styling ■ Metal logo

METAL AS F*CK

NO COMPROMISES, NO EXCUSES, NO APOLOGIES

HT METAL SERIES

Extreme high gain tones and custom cosmetics make these new valve amplifiers the ultimate metal tone machines. From a 1 Watt combo to a 6L6 loaded 100W head, they deliver a full-on Blackstar metal assault.

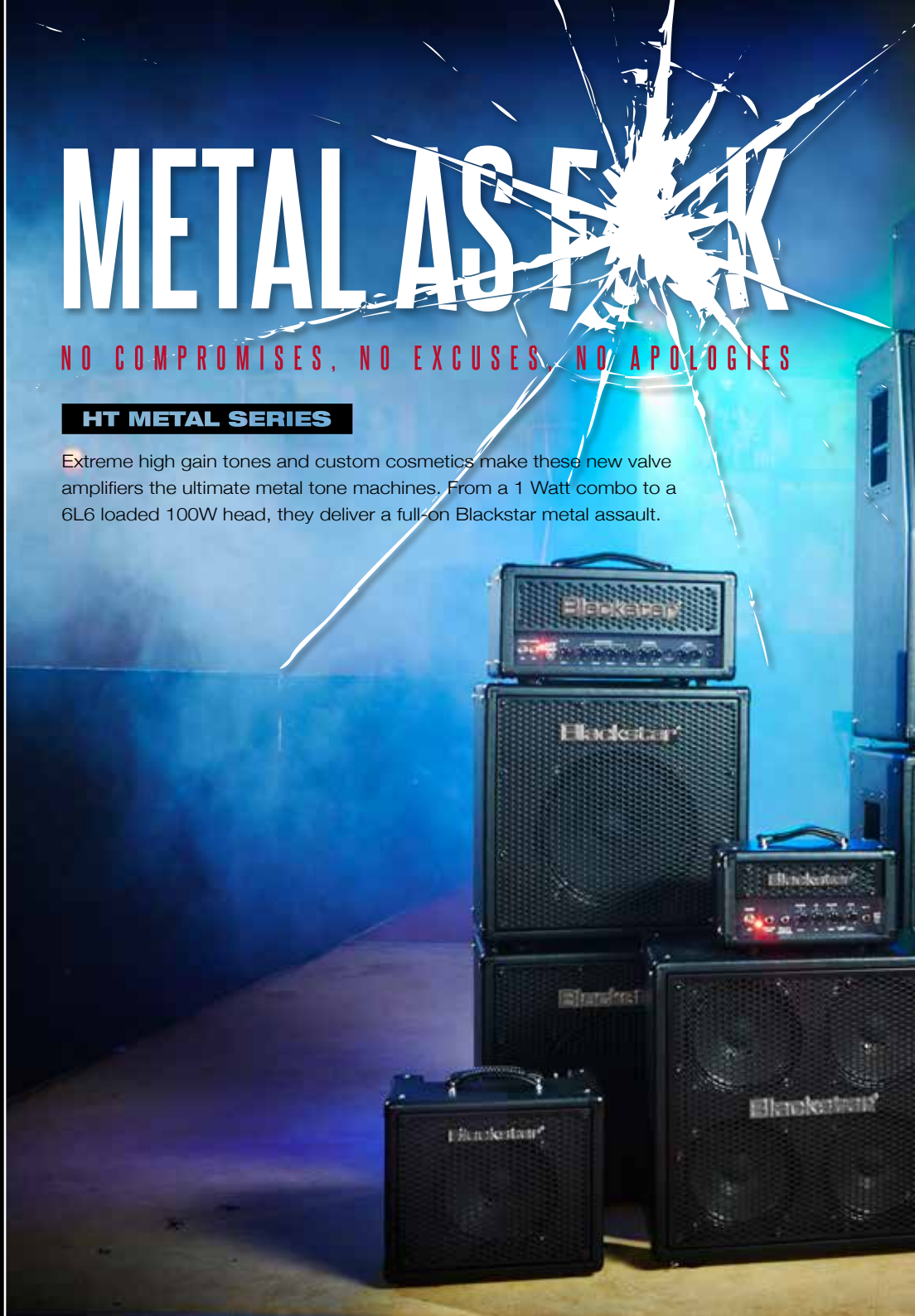



Guitarist
CHOICE

HT Metal 60

Guitarist
GOLD

HT Metal 5H

Total
Guitar
BEST BUY

HT Metal 5H

Total
Guitar
BEST BUY

HT Metal 60

HT METAL 60

This 60 Watt, three channel 2x12 valve combo delivers crushing metal tone on stage and in the studio via its 6L6 power stage.

- 60 Watt valve combo
- 2 x ECC83, 1 x ECC82, 2 x 6L6
- Three footswitchable channels (footswitch included)
- 2 x 12" Celestion speakers
- Patented Infinite Shape Feature (ISF)
- Clean Voice switch
- Presence
- Resonance
- Master Volume
- Digital reverb with dark/bright switch
- Speaker emulated output with 1x12 / 4x12 voicing
- Effects loop with effects level switch
- Reverb with dark/light switch
- Custom 'metal' styling
- Metal logo

HT METAL 100

This powerhouse 100 Watt head delivers three channels of brutal metal tones via a quartet of 6L6 valves. Add in reverb, an emulated output, 4-way footcontroller and effects loop and you have an amp fully equipped for stage or studio.

- 100 Watt valve head
- 2 x ECC83, 1 x ECC82, 4 x 6L6
- Three footswitchable channels (footswitch included)
- Patented Infinite Shape Feature (ISF)
- Clean Voice switch
- Presence
- Resonance
- Master Volume
- Digital reverb with dark/bright switch
- Speaker emulated output with 1x12 / 4x12 voicing
- Effects loop with effects level switch
- Reverb with dark/light switch
- Custom 'metal' styling
- Metal logo

HT METAL 408

- 60W 4x8" mono extension cabinet
- Metal grille
- Metal logo

HT METAL 112

- 50W 1x12" mono extension cabinet
- Blackbird 50 speaker custom designed by Blackstar
- Metal grille
- Metal logo

HT METAL 412A/B

- 320W angled/straight extension cabinet
- Mono / stereo
- Finger-jointed construction
- Heavy gauge wire
- 4 x Celestion 12" loudspeakers
- Metal logo

Bl

POWER STANDBY



ON ON



HT
5

REVERB



LEVEL



ISF

EQU

TRE

HT
5

Killer tones and innovative features make the HT-5 the ultimate studio and practice valve amp.

ckstar®

EQUALISATION OVERDRIVE CLEAN INPUT
BLE MIDDLE BASS VOLUME GAIN OVERDRIVE SELECT TONE VOLUME



HT-5C COMBO

Thanks to the unique 5W push-pull design, the HT-5C combo delivers huge tone at any volume.

- Innovative 5 Watt valve combo
- 1 x ECC83 and 1 x 12BH7 valves
- Unique push-pull power amp design
- Award-winning HT Pedal preamp
- Two footswitchable channels
- 12" Blackstar Blackbird 50 speaker
- Patented Infinite Shape Feature (ISF)
- Speaker emulated output with 1x12 / 4x12 voicing
- Effects loop with effects level switch
- Footswitch included

HT-5R COMBO

The HT-5R takes the tone and features of the HT-5C and adds the same stereo reverb as used in the acclaimed HT Venue Series.

- Innovative 5 Watt valve combo
- 1 x ECC83 and 1 x 12BH7 valves
- Unique push-pull power amp design
- Award-winning HT Pedal preamp
- Two footswitchable channels
- 12" Blackstar Blackbird 50 speaker
- Patented Infinite Shape Feature (ISF)
- Reverb
- Speaker emulated output with 1x12 / 4x12 voicing
- Effects loop with effects level switch
- Footswitch included

HT-5RH HEAD

The HT-5RH is a head version of the HT-5R combo. With all the same great features and tone it's compact and portable, and more than capable of driving a 4x12!

- Innovative 5 Watt valve head
- 1 x ECC83 and 1 x 12BH7 valves
- Unique push-pull power amp design
- Award-winning HT Pedal preamp
- Two footswitchable channels
- Patented Infinite Shape Feature (ISF)
- Reverb
- Speaker emulated output with 1x12 / 4x12 voicing
- Effects loop with effects level switch
- Footswitch included





HT-5R

HT-5RH HEAD

The HT-5RH is a head version of the HT-5R combo. With all the same great features and tone it's compact and portable, and more than capable of driving a 4x12!

- Innovative 5 Watt valve head
- 1 x ECC83 and 1 x 12BH7 valves
- Unique push-pull power amp design
- Award-winning HT Pedal preamp
- Two footswitchable channels
- Patented Infinite Shape Feature (ISF)
- Reverb
- Speaker emulated output with 1x12 / 4x12 voicing
- Effects loop with effects level switch
- Footswitch included

HT-5RS MINI STACK

The HT-5RS mini stack combines the HT-5RH head with two 1x12 Blackstar voiced speaker cabinets.

- Innovative 5 Watt valve head
- 1 x ECC83 and 1 x 12BH7 valves
- Unique push-pull power amp design
- Award-winning HT Pedal preamp
- Two footswitchable channels
- Two 1x12" Blackstar Blackbird 50 loaded speaker cabinets
- Enhanced tone controls
- Patented infinite Shape Feature (ISF)
- Reverb
- Speaker emulated output with 1x12 / 4x12 voicing
- Effects loop with effects level switch
- Footswitch included

HT-5210 COMBO (Product not shown)

A 2x10" combo version of the critically acclaimed HT-5 valve amplifier.

- Innovative 5 Watt valve combo
- 1 x ECC82, 1 x 12BH7 valves
- Unique push-pull power amp design
- Award-winning HT Pedal preamp
- Two footswitchable channels
- 2x10" speakers
- Patented Infinite Shape Feature (ISF)
- Speaker emulated output with 1x12 / 4x12 voicing
- Effects loop with effects level switch
- Footswitch included

HT-112

- 50W / 16 Ohm 1x12" mono extension cabinet
- Blackbird 50 speaker custom designed by Blackstar

www.blackstaramps.com/ht-5

Black

POWER



ON



MP3 / LINE
INPUT



EMULATED
OUTPUT &
HEADPHONES

REVER



LEVEL



HT 1

The HT-1 is the perfect studio and practice amp, packing all the great tone and innovative features of the award-winning HT-5 valve amp into a 1 Watt format.

HT 1

HT-1

The HT-1 is ideally suited to home and studio use, developed to sound full and toneful even at the lowest volume level.

- Innovative 1 Watt valve combo
- 1 x ECC83 and 1 x ECC82
- Unique push-pull power amp design
- Based on award-winning HT-5
- Two channels
- 8" speaker
- Patented Infinite Shape Feature (ISF)
- Perfect for studio or practice
- Speaker emulated output
- Stereo MP3 / Line input
- External speaker output

HT-1R

Following the success of the HT Venue range, The HT-1R utilises the same reverb design offering great tone for the studio or home.

- Innovative 1 Watt valve combo
- 1 x ECC83 and 1 x ECC82
- Unique push-pull power amp design
- Based on award-winning HT-5
- Two channels
- 8" speaker
- Patented Infinite Shape Feature (ISF)
- Perfect for studio or practice
- Speaker emulated output
- Stereo MP3 / Line input
- External speaker output
- Reverb





HT-1RH

The HT-1RH is the head version of the HT-1R combo. Toneful, portable and powerful enough to drive a 4x12.

- Innovative 1 Watt valve head
- 1 x ECC83 and 1 x ECC82
- Unique push-pull power amp design
- Based on award-winning HT-5
- Two channels
- Patented Infinite Shape Feature (ISF)
- Perfect for studio or practice
- Speaker emulated output
- Stereo MP3 / Line input
- External speaker output
- Reverb

HT-408

This 4x8 cabinet combines all the coolness of a 4x12 speaker cab into a compact format perfectly matched to the HT-1RH valve head. The awesome projection and tone from this small cab is unbelievable.

- 60W / 8 Ohm 4x8" mono extension cabinet



Best Guitar Combo 2011

HT-1R



HT-1R

www.blackstaramps.com/ht-1

Blackstar

INPUT



VOICE

OD 1
OD 2
SUPER CRUNCH
CRUNCH
CLEAR
CLEAR WARM



GAIN



VOLUME



LEVEL

LEVEL

BASS

BLACKSTAR



USB



MANUAL



BANK



CH 1

ID:SERIES

PROGRAMMABLE AMPLIFIERS

Our new ID:Series represents a truly groundbreaking achievement, combining unique innovations, an intuitive, traditional control set and the versatility of programmability.

Blackstar



ID:SERIES

PROGRAMMABLE AMPLIFIERS

Our new ID:Series represents a truly groundbreaking achievement, combining unique innovations, an intuitive, traditional control set and the versatility of programmability.

In the five years since its launch, Blackstar has led the way in the innovation of guitar amplification. The ID:Series represents the culmination of more than seven years technical research and development by the same team that designed Series One, Artisan and HT Venue. The unique controls allow you to custom design your own sound, store it and then have the confidence that the amp will perform in a live environment.

By using the unique Voice control, patented ISF and patent-applied-for True Valve Power, these amplifiers allow unparalleled flexibility and ease of use, enabling you to design the sound in your head and deliver it live as **LOUD as valve™**.

Deep editing and storing of patches is simple using the supplied Blackstar INSIDER software. Patches can be shared, uploaded and downloaded via our online community. The audio section allows you to play along to your MP3s, plus you can loop and time stretch sections for phrase training.





ID:15TVP

The ID:15TVP is a 15 Watt programmable combo perfect for use at home and in the studio. Powerful and articulate it delivers your sound.

- 15W 1x10" programmable combo
- True Valve Power – LOUD as valve™
- Voice – Clean Warm, Clean Bright, Crunch, Super Crunch, OD 1, OD 2
- 2 band EQ (3 via Blackstar INSIDER software) with patented ISF
- 128 user storable sounds
- Manual mode
- Multi effects – 4x modulations, 4x delays, 4x reverbs
- Master Volume
- USB connectivity – edit patches, record and reamp audio
- MP3/Line input
- Speaker emulated output
- INSIDER GUI software supplied for deep editing
- Built-in tuner
- Revolutionary tone

ID:30TVP

The ID:30TVP pushes 30 Watts of True Valve Power. This programmable combo performs whether in the studio or at small gigs and is the perfect lightweight and portable powerhouse.

- 30W 1x12" programmable combo
- True Valve Power – LOUD as valve™
- Voice – Clean Warm, Clean Bright, Crunch, Super Crunch, OD 1, OD 2
- 2 band EQ (3 via Blackstar INSIDER software) with patented ISF
- 128 user storable sounds
- Manual mode
- Multi effects – 4x modulations, 4x delays, 4x reverbs
- Master Volume
- USB connectivity – edit patches, record and reamp audio
- MP3/Line input
- Speaker emulated output
- INSIDER GUI software supplied for deep editing
- Built-in tuner
- Revolutionary tone

ID:60TVP

The ID:60TVP is a 60 Watt programmable 1x12" combo fully loaded with tone and features. This lightweight compact combo is at home in the studio or at live gigs.

- 60W 1x12 programmable combo ■ True Valve Power – LOUD as valve™ ■ Voice – Clean Warm, Clean Bright, Crunch, Super Crunch, OD 1, OD 2 ■ 3 band EQ with patented ISF ■ 128 user storable sounds
- Manual mode ■ Multi effects – 4x modulations, 4x delays, 4x reverbs ■ Resonance ■ Presence
- Master Volume ■ USB connectivity – edit patches, record and reamp audio ■ MIDI input ■ MP3/Line input ■ Speaker emulated output ■ INSIDER GUI software supplied for deep editing ■ Built-in tuner
- Revolutionary tone

ID:60TVP-H

The ID:60TVP-H is a 60 Watt programmable head version of the ID:60TVP combo, with the same great features in a classic head format.

- 60W programmable head ■ True Valve Power – LOUD as valve™ ■ Voice – Clean Warm, Clean Bright, Crunch, Super Crunch, OD 1, OD 2 ■ 3 band EQ with patented ISF ■ 128 user storable sounds
- Manual mode ■ Multi effects – 4x modulations, 4x delays, 4x reverbs ■ Resonance ■ Presence
- Master Volume ■ USB connectivity – edit patches, record and reamp audio ■ MIDI input ■ MP3/Line input ■ Speaker emulated output ■ INSIDER GUI software supplied for deep editing ■ Built-in tuner
- Revolutionary tone



ID:60TVP



ID:100TVP



ID:100TVP



ID:260TVP



ID:260TVP



ID:100TVP

The ID:100TVP is a 100 Watt programmable head. When paired with a matching ID:412 4x12 cabinet it becomes a killer gigging rig.

- 100W programmable head
- True Valve Power – LOUD as valve™
- Voice – Clean Warm, Clean Bright, Crunch, Super Crunch, OD 1, OD 2
- 3 band EQ with patented ISF
- 128 user storable sounds
- Manual mode
- Multi effects – 4x modulations, 4x delays, 4 reverbs
- Resonance
- Presence
- Master Volume
- USB connectivity – edit patches, record and reamp audio
- MIDI input
- MP3/Line input
- Speaker emulated output
- INSIDER GUI software supplied for deep editing
- Built-in tuner
- Revolutionary tone

ID:260TVP

The ID:260TVP is a 2 x 60 Watt stereo, programmable amp. With 2x12" speakers, this combo has a broad immersive sound and really packs a punch live.

- 60W + 60W 2x12 stereo programmable combo
- True Valve Power – LOUD as valve™
- Voice – Clean Warm, Clean Bright, Crunch, Super Crunch, OD 1, OD 2
- 3 band EQ with patented ISF
- 128 user storable sounds
- Manual mode
- Multi effects – 4x modulations, 4x delays, 4x reverbs
- Resonance
- Presence
- Master Volume
- USB connectivity – edit patches, record and reamp audio
- MIDI input
- MP3/Line input
- Speaker emulated output
- INSIDER GUI software supplied for deep editing
- Built-in tuner
- Revolutionary tone

ID:412 A/B

- 320W mono angled/straight extension cabinet
- 4x12" Celestion speakers
- 4 Ohm

FS:10

- Multi-function footcontroller
- Operates in three modes plus accesses the tuner
- Patch mode, Effects mode and Navigation mode

ID: CORE
PROGRAMMABLE AMPLIFIER

PLAY : BETT



ER : FASTER

SUPER
WIDESTEREO
ID: CORE



PLAY : BETTER : FASTER

ID:CORE is the ultimate entry level guitar amplifier series. Incredible tone and flexibility is accessed by a simple and intuitive control set and delivered in **SUPER WIDE STEREO**, to give an immersive playing experience that will have you hooked on playing guitar.

ID:CORE are small in size, but deliver huge tone – the perfect amps for budding guitarists who want to PLAY, BETTER, FASTER.



ID:CORE
PROGRAMMABLE AMPLIFIER



ID:Core Stereo 40

ID:Core Stereo 10

ID:Core Stereo 20



STEREO 10

STEREO 20

STEREO 40

12FX

IN SUPER WIDE STEREO

12 vintage style studio quality effects - 3x modulation, 3x delay and 3x reverb, specially voiced for electric guitar and delivered in massive **SUPER WIDE STEREO**

FREE
INSIDER
SOFTWARE

INSIDER software gives you more - deep editing of your amp, exchanging sounds with the Blackstar Online Community and downloading artist patches: all for free

VOICES

6 Blackstar voices deliver all the CORE tones you'll ever need - Bright Clean, Warm Clean, Crunch, Super Crunch, OD 1 and OD 2



Store your CORE ID sounds - 6 internally or more via free INSIDER software



USB audio for pro recording capability - easily capture your great tone



Speaker Emulated Line Out - for silent practice or recording

ISF

INFINITE SHAPE FEATURE

Patented ISF control takes you from the USA to the UK and anywhere in between

M3
LINE IN

Stereo MP3/Line In - for great sounding jamming or listening to music in **SUPER WIDE STEREO**

**SUPER
WIDESTEREO**
ID: CORE

FREE
ONLINE GUITAR LESSONS
Blackstar
POTENTIAL

FLY

3 WATT MINI AMP

NEW FOR 2015





a compact mini amp
with **BIG TONE**

...ON THE FEELY.



FLY

3 WATT MINI AMP



FLY 3 is THE compact mini amp for your guitar and your phone or tablet. Combining two channels, our patented Infinite Shape Feature (ISF) and a tape delay it's the perfect take-anywhere amp. Whether playing guitar, or playing your music, take your FLY 3 with you and always get 'the sound in your head'!

FLY 3 MINI AMP

- 3 Watts
- 2 Channels – Clean and Overdrive
- Patented ISF (Infinite Shape Feature)
- Digital 'tape' delay effect
- MP3 / Line In for jamming along or listening to music
- Emulated Line Out for 'silent' practice or recording
- 3" speaker producing true Blackstar tones
- Battery or DC powered
- Revolutionary sonic performance

FLY 103 EXTENSION CAB

- Turns the FLY 3 into a 6 Watt stereo set-up
- 3" speaker produces true Blackstar tones
- Revolutionary sonic performance

FLY STEREO PACK

- Pack contains FLY 3, FLY 103, plus power supply
- 6W stereo set up perfect for use as PC speakers and MP3 playback
- 2 Channels – Clean and Overdrive
- Patented ISF (Infinite Shape Feature)
- Digital 'tape' delay effect
- MP3 / Line In for jamming along or listening to music
- Emulated Line Out for 'silent' practice or recording
- 3" speakers produce true Blackstar tones
- Battery or DC powered (power supply included)
- Revolutionary sonic performance

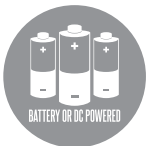

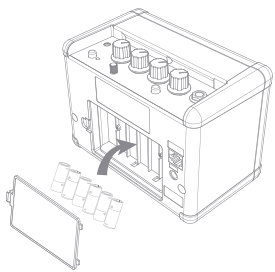

BATTERY OR DC POWERED
BATTERIES INCLUDED

MAKE YOUR SOUND STEREO

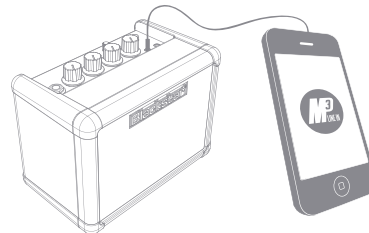
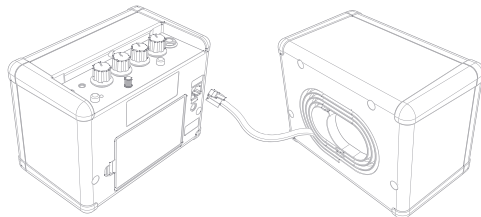

MP3 LINE IN FOR JAMMING
AND LISTENING TO MUSIC

...ON
THE
FLY.

A black, rectangular guitar amplifier with a textured leather-like finish. The front panel features a large, rectangular speaker grille with a woven mesh pattern. Above the grille, the brand name "Blackstar" is printed in white. The top of the amplifier has a control panel with several black knobs and a silver jack input. A black cable is plugged into the jack and loops around the side of the unit. The amplifier is sitting on a light-colored wooden surface. In the background, there is a dark-colored chair and a yellow and white patterned cushion.

Blackstar

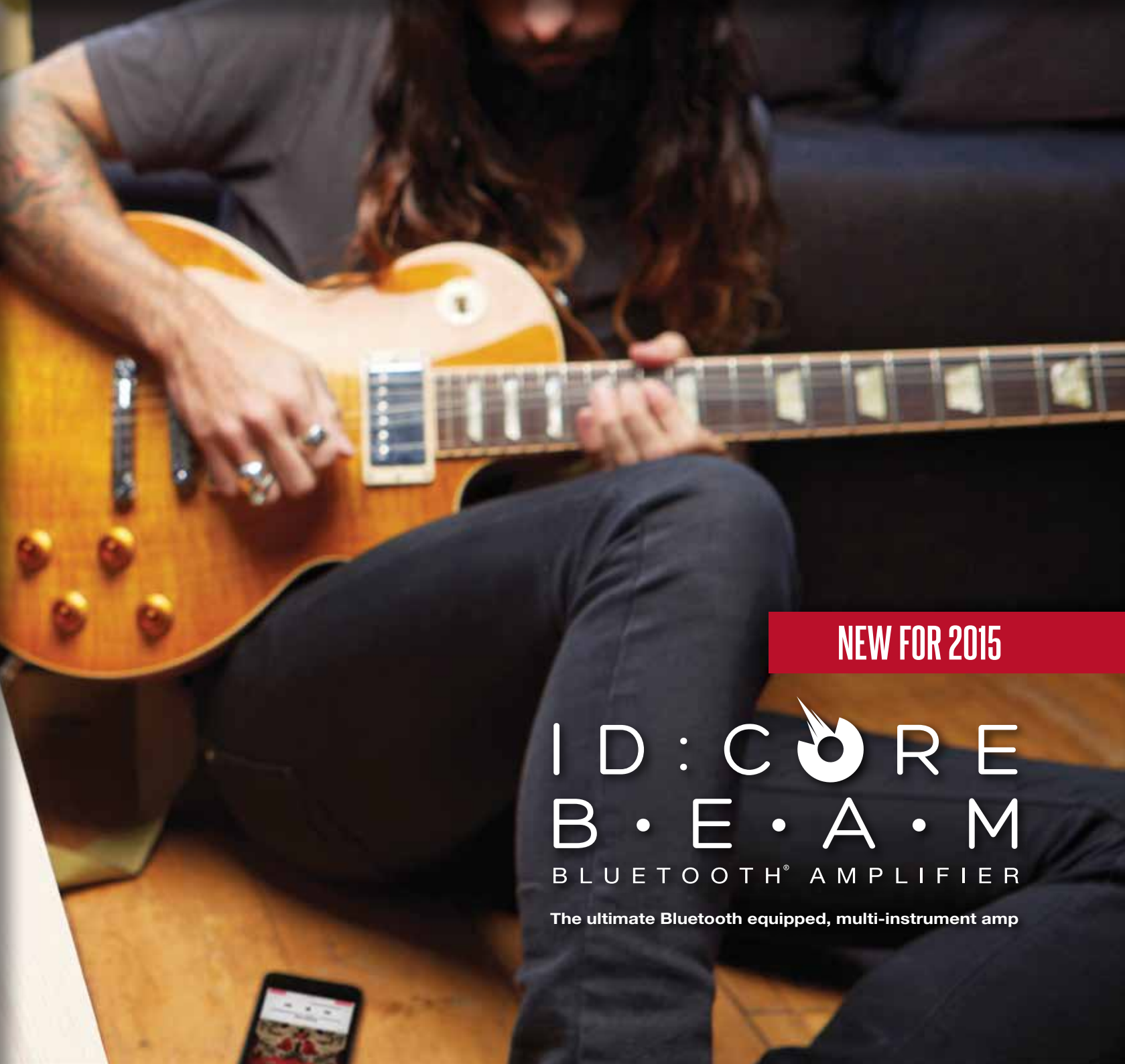

NEW FOR 2015

ID: CORE
B • E • A • M
BLUETOOTH® AMPLIFIER

The ultimate Bluetooth equipped, multi-instrument amp





Blackstar®

BASS · ELECTRIC · ACOUSTIC · MUSIC

ID:CORE BEAM is the ultimate Bluetooth equipped, multi-instrument amp.

Make listening to your Bluetooth audio a truly awesome experience with Blackstar's unique Super Wide Stereo technology. When it's time to play you get the same immersive room-filling sound for your electric, bass and acoustic guitar, with built-in vintage style effects for each. USB connectivity gives pro audio recording when creativity strikes. Compact and powerful it's everything you need to inspire your music – playing or listening.



ID:CORE B · E · A · M

BLUETOOTH® AMPLIFIER

ID:CORE BEAM

Specification:

- 20W Super Wide Stereo (2x10W) ■ Bluetooth connectivity for music streaming ■ Styled for use in the home ■ Separately sealed and ported chambers
- 6 electric guitar voices, from Clean Warm to OD 2
- 2 bass voices ■ 2 acoustic guitar voices ■ 2 acoustic simulator voices ■ Revolutionary sonic performance ■ Patented ISF ■ 12 vintage style digital effects per Voice ■ Programmable – store up to 12 patches, or use in Manual Mode ■ Full Blackstar INSIDER compatibility – create and share patches with the Blackstar Online Community ■ USB audio connectivity for playback and recording ■ MP3/Line In for jamming along or listening to music ■ Speaker Emulated Line Out for silent practice or recording
- Stereo speaker configuration – 2x3" speakers producing true stereo Blackstar tones ■ Mains powered via a separate power supply (included)

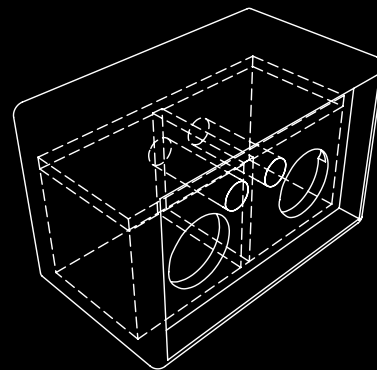

LT PEDALS

Compact Tones

Blackstar's patent-applied-for clipping circuit deliver valve tone and response in a series of 5 compact boost, drive and distortion pedals, tonally derived from our award-winning HT Pedals range.





LT BOOST

HOT ROD YOUR VALVE AMP

THE LT BOOST's gain circuit is designed to push your guitar amp into smooth overdrive and has been refined to ensure the maximum delivery of your dynamics and tone.

- Patent-applied-for clipping circuit
- Continuously variable boost
- Cut and boost tone controls
- 'Hot rod' your amp
- High integrity buffered bypass
- Silent switching



LT DRIVE

WARM BOOST TO SCREAMING LEAD SATURATION

The LT DRIVE delivers gain from warm boost to screaming lead saturation. Blackstar's clipping circuit delivers amazing valve-like tone and compression for a wide variety of playing styles.

- Patent-applied-for clipping circuit
- Warm boost to screaming lead
- Highly focussed tone control
- High integrity buffered bypass
- Silent switching



LT DIST

CLASSIC HIGH GAIN DISTORTION

The LT DIST features Blackstar's patented ISF (Infinite Shape Feature) circuit, giving you infinite adjustment over the characteristics of the tone control and taking you from the USA to the UK and anywhere in between.

- Patent-applied-for clipping circuit
- Classic drive to high gain
- Highly focussed tone control
- Patented Infinite Shape Feature (ISF)
- High integrity buffered bypass
- Silent switching



LT METAL

AGGRESSIVE HIGH GAIN TONES

The LT METAL is designed to deliver the aggressive high gain tones that modern guitarists need. It features Blackstar's patented ISF (Infinite Shape Feature) circuit, giving you infinite adjustment over the characteristics of the tone control and taking you from scooped US high gain to classic British heavy metal and anywhere in between.

- Patent-applied-for clipping circuit
- Extreme gain and tone
- Highly focussed tone control
- Patented Infinite Shape Feature (ISF)
- High integrity buffered bypass
- Silent switching



LT DUAL

TWO CHANNEL FLEXIBILITY

The LT DUAL offers the ultimate in distortion flexibility. Channel 1 lets you move from clean, to boost to overdrive. Channel 2 then takes you from super crunch right up to screaming lead. The unique switching operation will transform a single channel amp into a three channel tone machine.

- Two channels
- Patent-applied-for clipping circuit
- Highly focussed tone control
- Patented Infinite Shape Feature (ISF)
- Unique switching operation
- High integrity buffered bypass
- Silent switching



LT BOOST



LT DRIVE



LT DIST



LT DUAL



LT METAL

HT PEDALS

Heavenly Boxes

The award-winning HT valve overdrive pedals feature true high voltage (300V) circuitry and are packed with innovations and tone.



HT-METAL



HT-METAL



HT-DISTX



HT-DUAL



HT-BOOST

PURE VALVE BOOST

The HT-BOOST's high voltage gain circuit is like adding two extra hot valve stages to your amp so, unlike with inferior battery powered products, you don't lose any precious dynamics or tone.

- Genuine valve design ■ Operates at 300V HT
- Cascaded valve gain stages ■ Hot-rod your valve amp
- Silent switching operation ■ All valve tone control circuit
- Pedals or 'hot' valve amplifier outputs
- High integrity buffered bypass ■ Power supply included



HT-DRIVE

PURE VALVE OVERDRIVE

The HT-DRIVE has dual cascaded, high voltage triode stages which deliver gain from warm boost to screaming valve saturation. The unique 'A Class' tone control cuts the fizz without making your 'backed-off' tone sound dull and lifeless.

- Genuine valve design ■ Operates at 300V HT
- Cascaded valve gain stages ■ Responds like a valve amp
- Unique 'A-Class' tone control
- Fully equipped for stage or studio ■ Speaker emulated output
- High integrity buffered bypass
- Power supply included ■ Silent switching



HT-DIST

PURE VALVE DISTORTION

By allowing infinite adjustment over the characteristics of the HT-DIST's tone control network, the patented ISF circuit allows you to design your own tone and find the sound in your head.

- Genuine valve design ■ Operates at 300V HT
- Cascaded valve gain stages ■ Responds like a valve amp
- Unique enhanced tone controls
- Patented Infinite Shape Feature (ISF) ■ Fully equipped for stage or studio
- Speaker emulated output
- High integrity buffered bypass ■ Power supply included
- Silent switching



HT-DISTX

PURE VALVE FILTH

The HT-DISTX is a no-compromise, ultra high gain, filth machine. The tone has been benchmarked against the best high-gain valve amps in the world and will transform your mild mannered classic into a fire breathing monster.

- Genuine valve design ■ Operates at 300V HT
- Cascaded valve gain stages ■ Responds like a valve amp
- Unique enhanced tone controls
- Extreme gain and tone ■ Patented Infinite Shape Feature (ISF) ■ Fully equipped for stage or studio
- Speaker emulated output ■ High integrity buffered bypass
- Power supply included
- Silent switching



HT-DUAL

PURE VALVE DISTORTION

The HT-DUAL offers the ultimate in high voltage valve distortion flexibility. Channel 1 has either Clean or Crunch modes so it can be used clean, as a boost or overdrive. Channel 2 gives distortion tones from super crunch right up to screaming lead. The unique switching operation will transform a single channel amp into a three channel tone machine.

- Genuine valve design ■ Operates at 300V HT
- Cascaded valve gain stages ■ Responds like a valve amp
- 2 channel operation ■ Clean, Crunch and Lead modes
- Unique switching operation
- Unique enhanced tone controls ■ Patented Infinite Shape Feature (ISF) ■ Fully equipped for stage or studio
- Speaker emulated output
- High integrity buffered bypass ■ Power supply included
- Silent switching



HT-METAL

PURE VALVE FILTH

The HT-METAL valve distortion pedal is a no-compromise, two channel, ultra high gain, filth machine. Powered by true 300V high-voltage valve circuitry, this pedal offers cascaded valve gain stages for an authentic valve amp response. Each ultra-high gain channel offers its own gain and volume controls. Channel 1 is equipped with a Clean/Overdrive switch.

- Genuine valve design ■ Operates at 300V HT
- Cascaded valve gain stages ■ Extreme Gain and Tone
- Responds like a valve amp ■ 2 channel operation
- Clean, Overdrive and Super High Gain Lead modes
- Unique switching operation ■ Unique enhanced tone controls
- Patented Infinite Shape Feature (ISF) ■ Fully equipped for stage or studio
- Speaker emulated output ■ High integrity buffered bypass
- Power supply included ■ Silent switching



HT PEDALS

Valve effects performance

Combining real valve tone with the flexibility of digital technology these pedals deliver eight stunning reverb, delay and modulation effects.



HT-REVERB

VALVE REVERB

The HT-REVERB can take you from your room to an arena via hall, plate, spring, gate and reverse reverb effects. Valve compression and harmonics are added using the Dwell control, and you can switch the reverb time from short to long while you are playing.

- 8 reverb effects
- Genuine valve design
- Operates at 300V HT
- Unique Dwell control
- Manual and Short/Long modes
- Stereo
- Unique switching operation
- High integrity buffered bypass
- Power supply included
- Silent switching



HT-DELAY

VALVE DELAY

With eight different delays in one pedal, the HT-DELAY can take you from vintage and multihead tape delays, through to classic analogue and linear full bandwidth effects, and includes two versatile loop modes as well. You can then add in real valve compression and harmonics using the unique Saturation control.

- 8 delay effects
- Genuine valve design
- Operates at 300V HT
- Unique Saturation control
- Tap and two Loop modes
- Stereo
- Unique switching operation
- High integrity buffered bypass
- Power supply included
- Silent switching



HT-MODULATION

VALVE MODULATION

From gentle tremolo to roaring jet engine flange, the HT-MODULATION brings you all the musicality of classic vintage effects pedals. For ease of use the Slow/Fast feature lets you adjust the modulation time of the eight different modulation effects while you are playing. The unique Saturation control then lets you add real valve compression and harmonics.

- 8 modulation effects
- Genuine valve design
- Operates at 300V HT
- Unique Saturation control
- Manual and Slow/Fast modes
- Stereo
- Unique switching operation
- High integrity buffered bypass
- Power supply included
- Silent switching

Product Front Panels

SERIES ONE

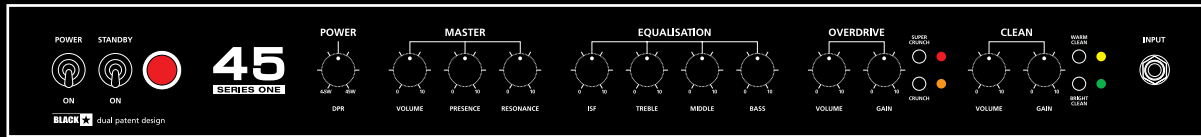

Series One 45

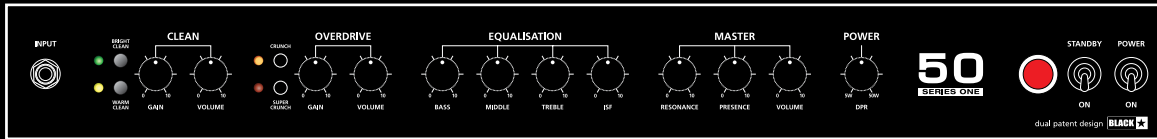

Series One 50

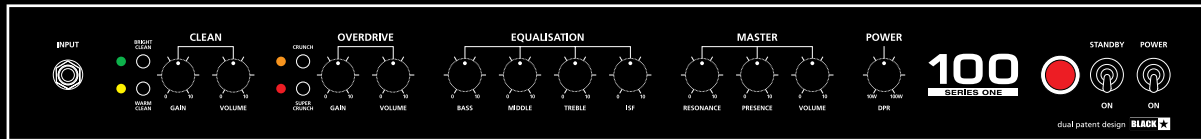

Series One 100

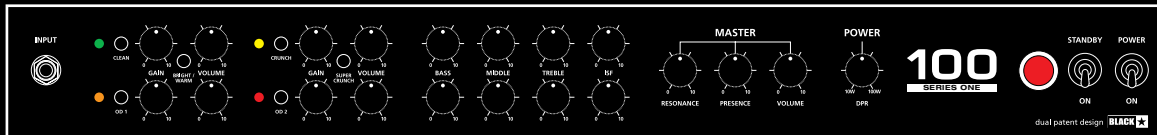

Series One 104EL34

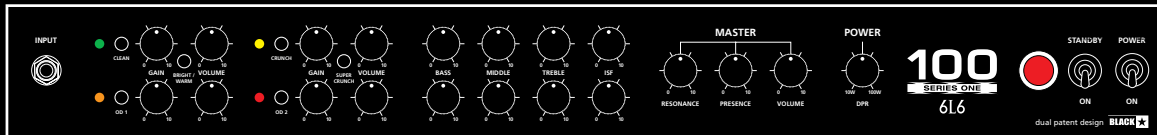

Series One 1046L6

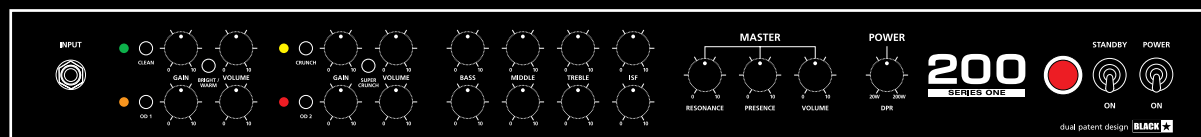

Series One 200

HANDWIRED
ARTISAN SERIES
 AMPLIFIERS

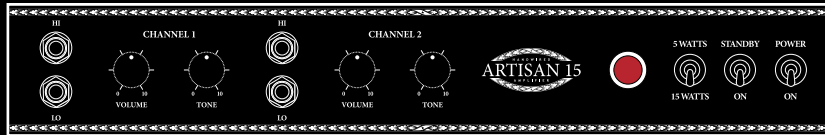

Artisan 15

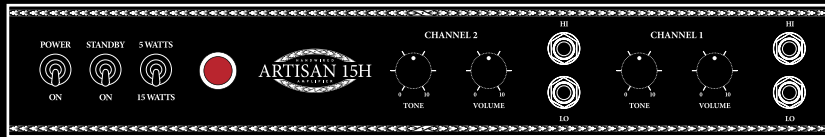

Artisan 15H

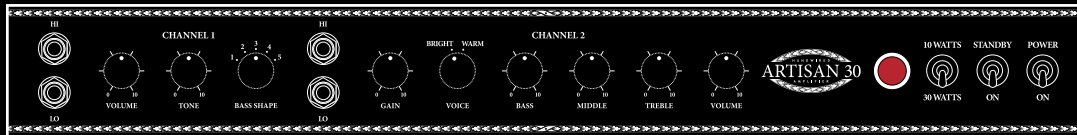

Artisan 30

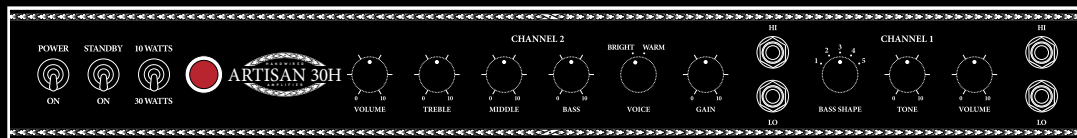

Artisan 30H

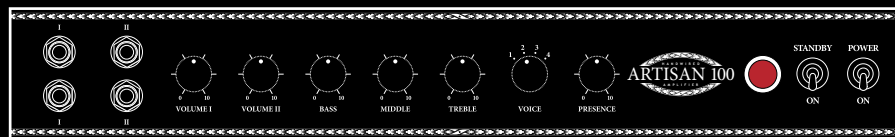

Artisan 100

HT VENUE SERIES

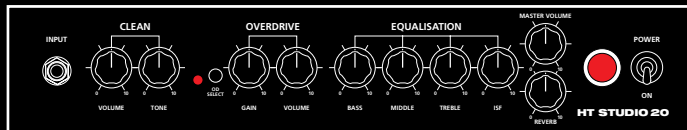

HT Studio 20

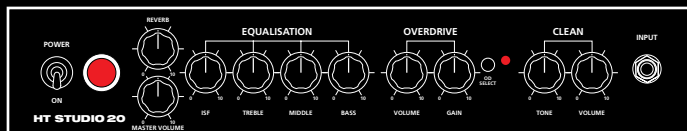

HT Studio 20H

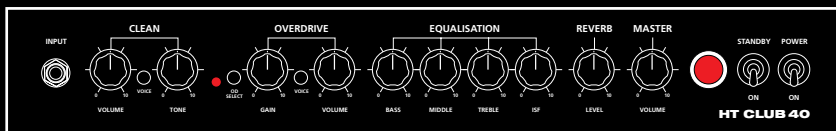

HT Club 40

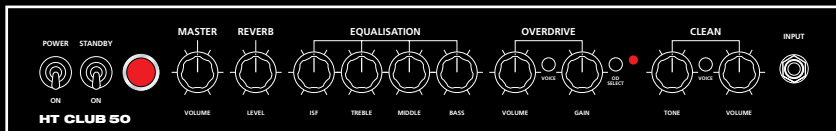

HT Club 50

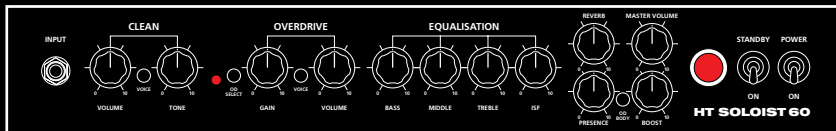

HT Soloist 60

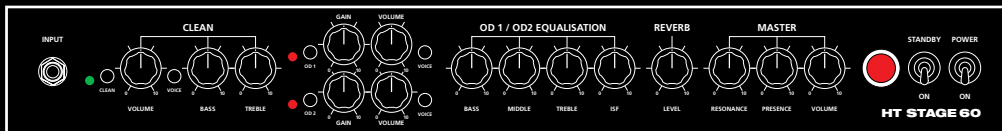

HT Stage 60

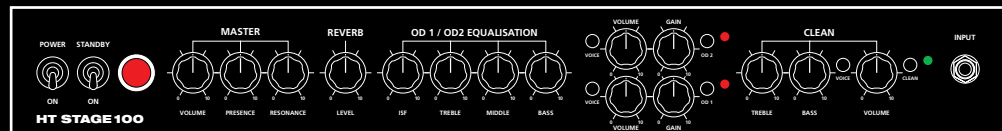

HT Stage 100

HT METAL SERIES

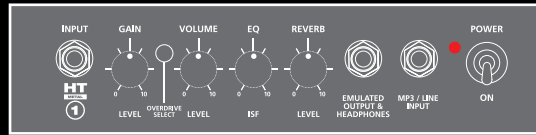

HT Metal 1H

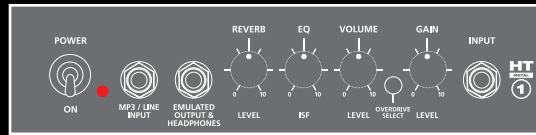

HT Metal 1

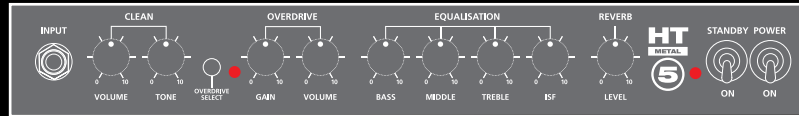

HT Metal 5H

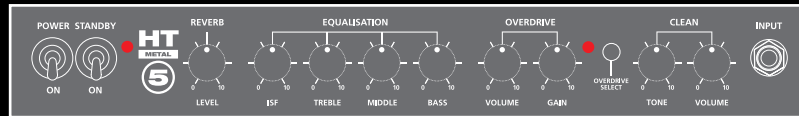

HT Metal 5

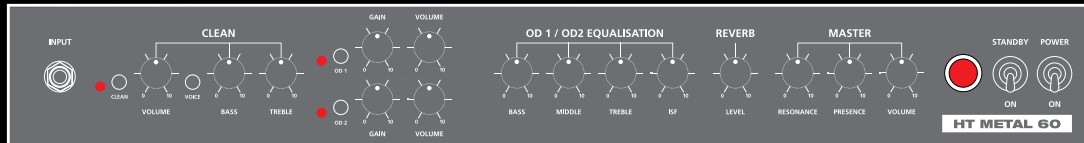

HT Metal 60

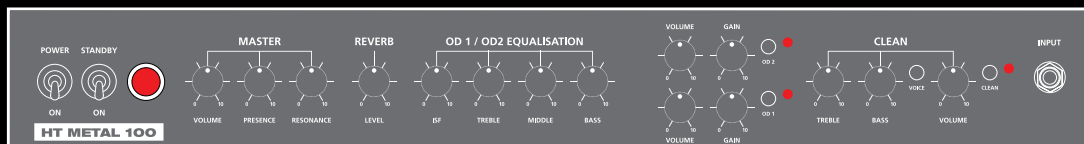

HT Metal 100

HT 5

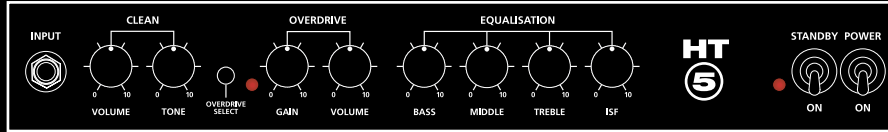

HT-5C

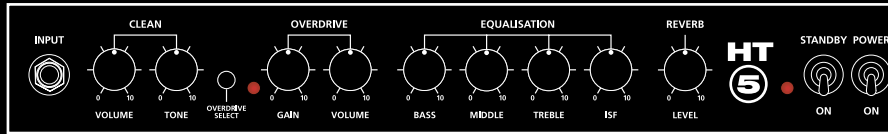

HT-5R

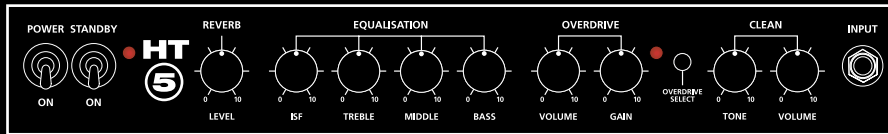

HT-5RH

HT 1

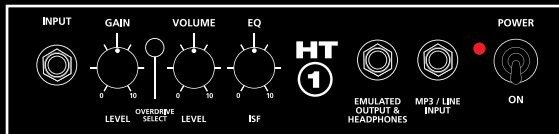

HT-1

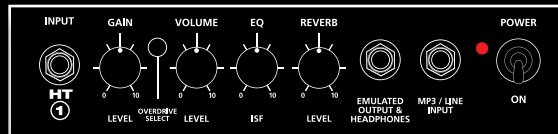

HT-1R

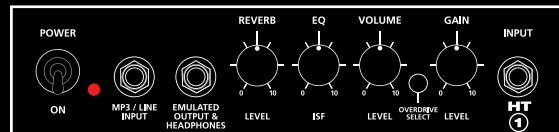

HT-1RH

ID:SERIES

PROGRAMMABLE AMPLIFIERS

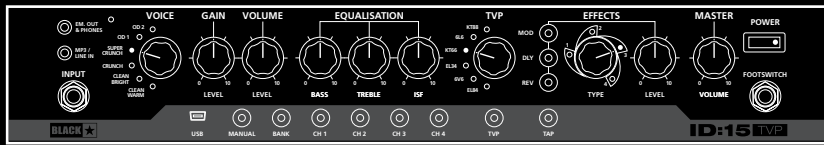

ID:15TVP

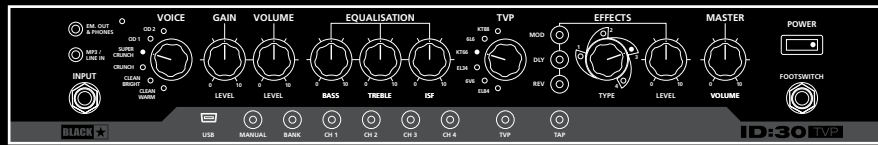

ID:30TVP

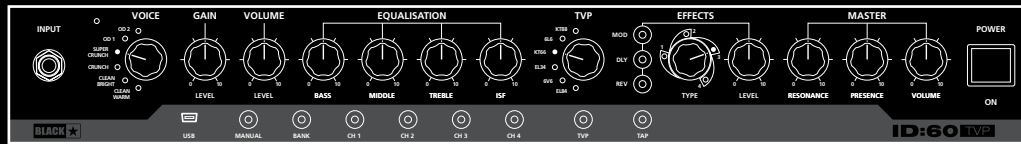

ID:60TVP

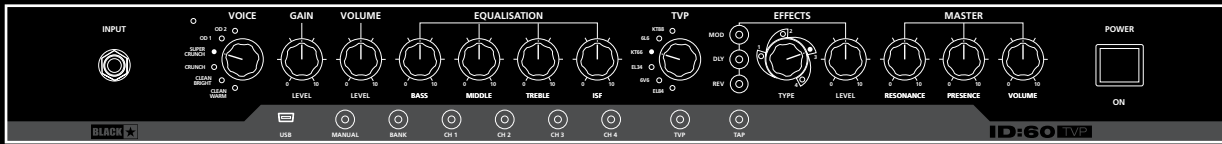

ID:60TVP-H

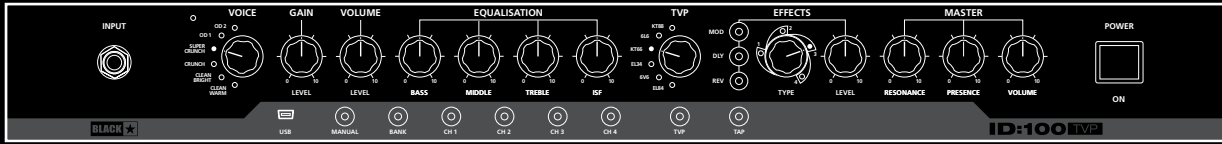

ID:100TVP

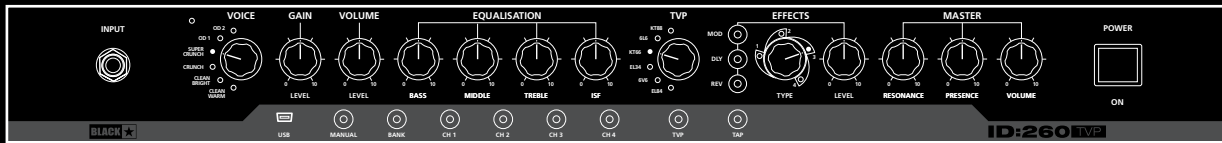

ID:260TVP

ID: CORE

PROGRAMMABLE AMPLIFIER



ID: CORE STEREO 10



ID: CORE STEREO 20

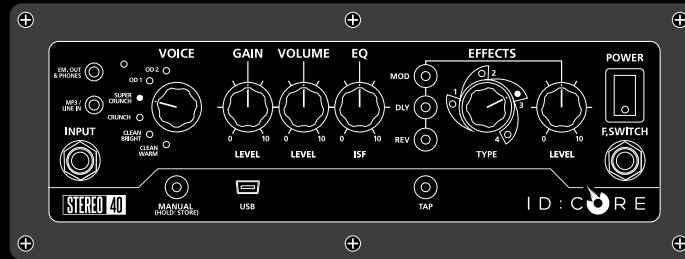

ID: CORE STEREO 40

FLY
3 WATT MINI AMP

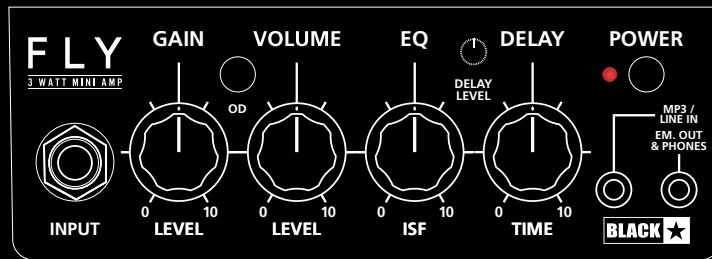

FLY 3

Aaron Aedy – Paradise Lost
 Adam Smethurst – Dear Superstar
 Adamsky – Cold In Berlin
 Adrian Mottram – Sights and Sounds
 AJ Perdomo – The Dangerous Summer
 Alan Price – Monster Energy UK
 Alastair Greene – Alan Parsons Project
 Alex Baker – Kerrang!
 Alex Dickson – Calvin Harris
 Alli Hodge – Feed Me Music
 Andrea Odendahl
 Andrew Neufeld – Comeback Kid, Sights and Sounds
 Andy Cairns – Therapy?
 Andy Dimmack – Guitar Tech
 Andy Gill – Gang Of Four
 Andy Mack – Million Dollar Reload
 Angel Ibarra – Aiden
 Ant West – Futures
 Arran Day – This City
 Ashley Riot – Riot:Noise
 Aziz Ibrahim
 Banks
 Barney Cushman – Symphony Cult
 Barry Burns – Mogwai
 Ben Christo – The Sisters Of Mercy
 Beckie Sugden – The Agency Group
 Ben Hogan – Jody Has A HITLIST
 Ben Jones – Kelly Rowland, Westlife
 Ben Lloyd – Frank Turner
 Ben Sansom – Lower Than Atlantis
 Bernd Himsl – The Cassidy Scenario
 Bernd Kurzke – Beatsteaks
 Big Jim Sullivan – RIP
 Big Noise Studios, Northampton
 Billy F. Gibbons – ZZ Top

Bill Reynolds – Band of Horses



Bloodstock, UK
 Brighton Electric Recording Co.
 Broady – Eremo J
 Bryan Czap – The Dangerous Summer
 Buz McGrath – Unearth
 Calvin Roffey – The Smoking Hearts
 Carlos Garcia
 Carlos Cavazo – RATT
 Cavern Club, Liverpool
 Charlie Simpson – Fightstar
 Chet Haun – Guitar Tech
 Chris Batten – Enter Shikari
 Chris Catalyst – The Sisters Of Mercy, Eureka Machines
 Chris Cayford – Rolo Tomassi
 Chris Chasse – Nations Afire

Chris Demakes – Less Than Jake



Chris Ketley – Ellie Goulding
 Chris Pennels – Deaf Havana
 Chris Tsangarides – Producer
 Cody Payne – The Dangerous Summer
 Daniel P Carter – Bloodhound Gang, Hexes
 Dan Fretwell – Marines
 Dai Pritchard – Rose Tattoo
 Dan 'Pitau' Rice – Hadouken!
 Dan M Hicks – Mordecia
 Dan Richards – One Direction
 Dan Weller – Silkth, Producer
 Daniel Kingham – Pilots
 Darren Parkinson – The Dear & Departed
 Darren Toms
 Dave 'Bucket' Colwell – Bad Company, The Jones Gang
 Dave Draper – They Fell From The Sky
 Dave Leslie – Baby Animals
 Dave Nassie – Bleeding Through
 David Jones – The Crips, Nine Black Alps
 David Pontin – Platform
 David Ryder Prangley – Rachel Stamp
 Davo – Guitar Tech
 Dean Richardson – Heights
 Dean Roberts – Stewart Mac
 Declan Hart – Lower Than Atlantis
 Dee Bahl – 1554 Management
 Dennis Kayser – Time Has Come
 Deptford John – Guitar Tech
 Drew Foppe – Guitar Tech
 Dusty Redmond – The Almost
 Ed Harcourt
 Ed Oleszko – Queensbury
 Emre Savas – Guitar Tech
 Fabian Lomas – Polar
 Fraser Taylor – Young Guns
 Gareth Edwards – Queensbury
 Garry Lee – Front of House Tech
 Gavin Burrough – Funeral for a Friend
 George Vjestica – Groove Armada
 Gez Walton – Guitar Tech
 Gil Norton – Producer
 Giuliani (Jools) Gizzi – Gun
 Glen Rowe – CATO Music
 Greg Bergdorf – Zebrahead
 Greg Mackintosh – Paradise Lost
 Gwil Sainsbury – Alt J
 Hammerfest, UK
 Hard Rock Hell, UK
 High Voltage, UK
 Hit The Deck, UK

Hugh Harris – The Kooks
 Hugo Ferreira – Tantric
 Iain Manhanty – Kids in Glass Houses
 Ian Love – Rival Schools
 Ian Rubin – Angels and Airwaves
 Irwin Sparkes – The Hoosiers
 Jack Dunkley – Targets
 Jack Fairbrother – Natives
 Jag Jago – Ghost Of A Thousand
 Jake Thorsen – IMAI
 James Hetfield – Metallica
 James L'Esteve – Future Publishing
 James Mastro – Ian Hunter Band
 James Spence – Rolo Tomassi
 James Veck-Gilodi – Deaf Havana
 Jamie Bell – The Go! Team
 Jamie MacColl – Bombay Bicycle Club
 Jamie Woon
 Jan Paternoster – Black Box Revelation
 Jansen Press – Carousel Vertigo
 Jason Bannon – Cerebral Ballyz
 Jay Mehler – Kasabian
 Jay Rowe – Hexes
 Jay Thompson – Blacklight Pioneer
 Jeff Cease – Bucky Covington
 Jeff Sahyoun – Ietlive.
 Jet Storm – UK Subs
 Jim Davies – DJ Hyper, Victory Pill
 Jim Lindberg – Black Pacific
 Jimi Jimmi – Raven Vandelle
 Joe James – Blitz Kids
 Joe Newman – Alt J
 Joe Ward – Exit Ten
 Joel Estes – Anchored
 John Be – Tour Manager/Guitar Tech
 John Browne – Monuments
 John Dunford – Guitar Tech
 John Lodge – Pulp Stores
 John Phillips – Marines
 John Verity – Argent
 Johnnie Allen – Raw Power Management
 Johnny Chow – Soulfly
 Jolyon Dixon – Rachel Fuller
 Jon Claydon – MI-LA
 Jon Daily – Crazy Arm
 Jona Weinhofen – Bring Me The Horizon
 Jonny Pilcher – Athlete
 Jono Yates – Blitz Kids
 Jorge Escobedo – Sober
 Josh Havens – The Afters
 Justin Collier – Man Overboard
 Katie Parsons – Kerrang!
 Kav
 Kirk McKim – Pat Travers Band
 Koichi Fukuda – Static-X
 Kryz Reid – Third Eye Blind
 Laurent 'Lags' Barnard – Gallows
 Lee Burgess – The Rifles
 Lee Holden-Rushworth – Quarterblind
 Lenneke Knappe – Macbeth Footwear
 Lewis Allen – Pixie Lott, Jessie J
 Loren Molinare – The Dogs, Little Caesar
 Lucas Coe – Skyline
 Lucas Crowther – The Rifles
 Luke Bond – SevereZero
 Luke Bryan – The Luke Bryan Band

Lutz Buch – Guitar Tech
 Macbeth Footwear
 Marc Culke – Amy MacDonald
 Marc Stapleton – Guitar Tech
 Marcos Curiel – P.O.D.
 Mark Bishop – Producer, Universal Music, Kensington
 Mark Clayden – BIMM
 Mark Kozuch – Guitar Tech
 Mark McDonagh – Tour Manager
 Mark Verney – Slaves To Gravity
 Marshall Gill – New Model Army
 Martin Lamb – Tour Manager
 Martyn 'Nelsta' Nelson – King Adora
 Mason – Cerebral Ballzy

Mat Welsh – While She Sleeps



Matt Fuqua – The Afters
 Matt Garrity
 Matt Tagliaferra – Guitar Tech
 Matt Yonker – Less Than Jake
 Matty Lewis – Zebrahead
 Max Taylor – Groove Armada
 Mehdi Vismara – Bury Tomorrow
 Mick Brown – Guitar Tech
 Mickey Waters – The Answer
 Mike Keegan – Through It All Touring
 Mike Vennart – Oceansize

Misha Mansoor – Periphery



Mitch Gee – Exit Avenue
 Murphy Murphy – The Ghost Frequency
 Neil Zaza – Solo Artist
 Nate Wood – Taylor Hawkins and the Coattail Riders
 Nick James – Raven Vandelle
 Nick Meeks – Exit Avenue
 Nik Hill – Nations Afire, Ignite
 Nik Sorak – Corey Taylor and the Junk Beer Kidnap Band
 Nikki Murray

Nina Goetting – Kill Her First
 Nuno Miguel – Sons Of Albion
 Øystein Landsverk – Leprous
 P-A-U-L
 Pádraig McAlister – Jody has a Hitlist
 Parslow – Save Your Breath
 Pat Davern – Grinspoon
 Paul Brigstock – Ragstone
 Paul Guerin – Quireboys
 Paul Mahon – The Answer
 Peter Bullick – Deb Bonham
 Pollard Berrier – Archive
 Pontus Andersson – Dia Psalma
 Pontus Snibb – Bonafide
 Purple Turtle – London
 Randy Bachman – Bachman-Turner Overdrive
 Ray Hatfield – Wishbone Ash
 Reeves Gabrels – David Bowie
 Reuben Gotto – Johnny Truant
 Rhys Bradley – To The Bones
 Ric Gingell – Get Vegas
 Rich Hiorns – TRC
 Rich Jones – The Loyalties
 Rick Graham – Guitar Tech
 Rikki Glover – Skinny Machines
 Roadmender, Northampton
 Rob Marshall – Exit Calm
 Rob Riot – Spit Like This
 Roddy Stone – Viking Skull
 Roger Manganelli – Less Than Jake
 Roger Nowell – Tour Manager
 Romesh Dodangoda – Producer
 Ross Colgan – The Ghost Frequency
 Russ Poke – Stars Of The Search Party
 Ryan Jarman – The Crips
 Sam Duckworth – Get Cape. Wear Cape. Fly
 Sam Halliday – Twenty Twenty
 Sam Kearny – Alberta Cross
 Sam McTrusty – Twin Atlantic
 Sascha Eigner – Jupiter Jones
 Scott Middleton – Cancer Bats
 Sean Harrison – Guitar Tech
 Sean Long – While She Sleeps
 Sharon Richardson – Factory Music
 Simon Hall – Bloodstock
 Simon Bloor – The Odd Squad
 Simon Delaney – Don Broco
 Simon Humphries – Failsafe
 Simon Rowlands – My Passion
 Solj – Guitar Tech
 Sonisphere, UK
 Stelios Kalisperides
 Stephen Carter – Kylie Minogue
 Stephen McElroy – Australian Pink Floyd
 Steve Conte – Michael Monroe
 Steve Mann – They Will Rise
 Stephen Egerton – Descendants
 Stewart Mac
 Stewy Milton – Dear Superstar
 Stu Gill-Ross – Gallows
 Stuart Steele – Exit Ten
 T.O. – Save Your Breath
 Te Ara Dirsk – Monster Energy UK
 The Lodge Studio, Northampton

Thomas Van Elslander – K's Choice
 Tim Boardman – Guitar Tech
 Tim Neale – Pythia
 Timothy Vega – Kobra and the Lotus
 Tobe Bean – Streetdogs
 Tom Green – Heights
 Tom Harrison – The Hype Theory
 Tom Hauser – The Cassidy Scenario
 Tom Lilleywhite – Targets
 Tor Oddmund Suhrke – Leprous
 Trevor Bolder – Uriah Heep

Troy Seele - Iced Earth



Vic Johnson – The Waboritas
 Vincent Hyde – The Defiled
 Vincent Martinez – Carousel Vertigo
 Wayne Plummer – Emilie Sande
 Wayne Wildrick – Man Overboard
 Will Foster – The Fratellis, Lodger, Bermudan

Will Sergeant – Echo and the Bunnymen



Willy Willy – The Scabs
 Yemcy – The 925's
 Yves Lelevier – Juliette Lewis Band
 Zac Eisenstein – Man Overboard
 Zach Harmon – Tour Production
 Zach Myers – Shinedown

...and all the other Blackstar
 players around the world.